

moonscape™
Outdoor Lights NZ



Magic in your garden



moonscape lighting

Your home, your sanctuary, now extends outdoors with MOONSCAPE[®]. Create a magical ambience where you can relax or entertain in the evenings under the stars with this exceptional lighting range.

Choose the mood and feeling you want to create and MOONSCAPE[®] exterior luminaries can make it happen. Magical, elegant, informal or minimalist - MOONSCAPE[®] architectural simplicity in a wide range of finishes allows for any kind of creative lighting expression at home - or in a commercial setting.

Heavy rainfall, corrosive sea air, extreme temperature ranges - MOONSCAPE[®] has been purpose-designed and manufactured in New Zealand to withstand the harsher elements of New Zealand and Australia climatic conditions. The materials are of a high grade nature. 99.9% Aluminium Marine Grade anodised. 99% Copper, brass - glass filled, flame retardant UV stabilised plastic components. All fastenings are stainless steel.



MOONSCAPE[®] creates a whole new outdoor environment for you to enjoy.

contents

Garden lights	02
Includes Spot, Uplights, Eco, Spread, Path and Bollards	
Step & Inground lights	04
Includes Step, Uplights, Skim, Mini step, Lawn and Under Water lights	
Wall lights	08
Includes Surface and Recessed lights	
Accessories	11
Includes Glare Shields, Cans, Filters, LED lamps, Cables, Transformers, Ground Spikes, Flanges	



Spotlight adjustable with ground spike

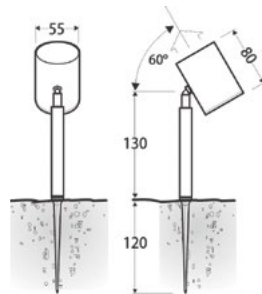

RANGE

Raw Copper
SPLA-GS100-CO
SPLA-GS300-CO
SPLA-GS600-CO

Natural Anodised
SPLA-GS100-SN
SPLA-GS300-SN
SPLA-GS600-SN

Black Anodised
SPLA-GS100-BK
SPLA-GS300-BK
SPLA-GS600-BK

SPECIFICATIONS

- Spun raw Copper
- Spun raw Aluminium
- Marine anodised to 25 microns (um)
- IP Rating - IP65
- LAMPS**
- 12V LED MR16 3 - 10W
- OPTIONS**
- Remote transformer 12 Volt



Uplight Fixed with ground spike

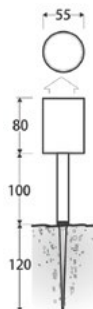

RANGE

Raw Copper
UL-FXGS-CO

Natural Anodised
UL-FXGS-SN

Black Anodised
UL-FXGS-BK

SPECIFICATIONS

- Spun raw Copper
- Spun raw Aluminium
- Marine anodised to 25 microns (um)
- IP Rating - IP65
- LAMPS**
- 12V LED MR16 3 - 10W
- OPTIONS**
- Remote transformer 12 Volt



Eco adjustable with ground spike

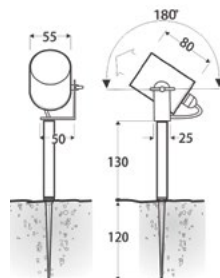

RANGE

Raw Copper
ECOSPOT-CO

Natural Anodised
ECOSPOT-SN

Black Anodised
ECOSPOT-BK

SPECIFICATIONS

- Spun raw Copper
- Spun raw Aluminium
- Marine anodised to 25 microns (um)
- IP Rating - IP65
- LAMPS**
- 12V LED MR16 3 - 10W
- OPTIONS**
- Remote transformer 12 Volt



Spotlight Twin adjustable with ground spike

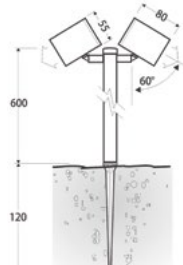

RANGE

Raw Copper
SPLTA-GS600-CO

Natural Anodised
SPLTA-GS600-SN

Black Anodised
SPLTA-GS600-BK

SPECIFICATIONS

- Spun raw Copper
- Spun raw Aluminium
- Marine anodised to 25 microns (um)
- IP Rating - IP65
- LAMPS**
- 12V LED MR16 3 - 10W
- OPTIONS**
- Remote transformer 12 Volt





Spread Light with ground spike

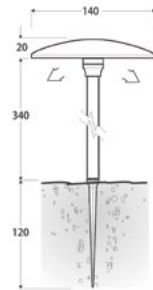

RANGE

Raw Copper
SPRL-CO

Natural Anodised
SPRL-SN

Black Anodised
SPRL-BK

SPECIFICATIONS

- Spun raw Copper
 - Spun raw Aluminium Marine anodised to 25 microns (um)
 - IP Rating - IP64
- LAMPS**
- 12V LED G4 Capsule 1 - 3W
- OPTIONS**
- Remote transformer 12 Volt



Path Light with ground spike

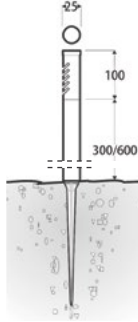

RANGE

Raw Copper
PATHL-400-CO
PATHL-700-CO



Natural Anodised
PATHL-400-SN
PATHL-700-SN



Black Anodised
PATHL-400-BK
PATHL-700-BK

SPECIFICATIONS

- Spun raw Copper
 - Spun raw Aluminium Marine anodised to 25 microns (um)
 - IP Rating - IP64
- LAMPS**
- 12V LED G4 Capsule 1 - 3W
- OPTIONS**
- Remote transformer 12 Volt



Bollard round 390 / 750mm

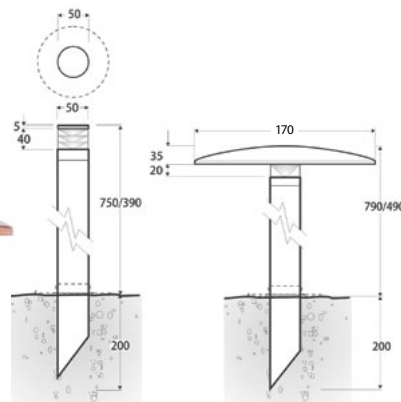

RANGE

Raw Copper
BL-390-CO
BL-750-CO

BLSL-170-CO*



Natural Anodised
BL-390-SN
BL-750-SN

BLSL-170-SN*



Black Anodised
BL-390-BK
BL-750-BK

BLSL-170-BK*

SPECIFICATIONS

- Spun raw Copper
 - Spun raw Aluminium Marine anodised to 25 microns (um)
 - IP Rating - IP64
- LAMPS**
- 12V LED MR16 5W
- OPTIONS**
- Remote transformer 12 Volt

NOTE *

- **BLSL-170-CO/SN/BK** is Round Bollard including Top Hat



Bollard square

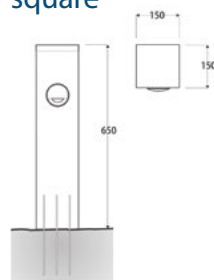

RANGE

Square Solid Timber
BL-SST-650

SPECIFICATIONS

- Spun raw Copper
 - IP Rating - IP65
- LAMPS**
- 12V LED MR16 3 - 10W
- OPTIONS**
- Remote transformer 12 Volt



Step Light eyelid
recessed

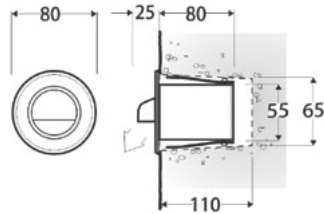

RANGE
Raw Copper
STPL-SB-CO



Natural Anodised
STPL-SB-SN



Black Anodised
STPL-SB-BK

SPECIFICATIONS

- Spun raw Copper
- Spun raw Aluminium Marine anodised to 25 microns (um)
- IP Rating - IP65
- LAMPS**
- 12V LED MR16 3 - 10W
- OPTIONS**
- Remote transformer 12 Volt



Step Light louver
recessed

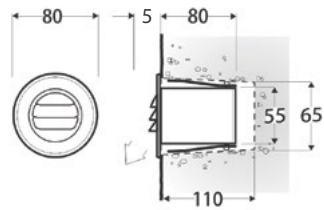

RANGE
Raw Copper
STPL-LV-CO



Natural Anodised
STPL-LV-SN



Black Anodised
STPL-LV-BK

SPECIFICATIONS

- Spun raw Copper
- Spun raw Aluminium Marine anodised to 25 microns (um)
- IP Rating - IP65
- LAMPS**
- 12V LED MR16 3 - 10W
- OPTIONS**
- Remote transformer 12 Volt



Step Light machined
recessed

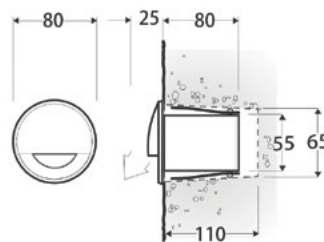

RANGE
Copper
STPL-MB-CO



Bronze finish
STPL-MB-BR



Natural Anodised
STPL-MB-SN



Black Anodised
STPL-MB-BK

SPECIFICATIONS

- Machined Bezel
- Spun raw Copper bodies
- Spun raw Aluminium bodies Marine anodised to 25 microns (um)
- IP Rating - IP65
- LAMPS**
- 12V LED MR16 3 - 10W
- OPTIONS**
- Remote transformer 12 Volt



Skim Light machined
recessed

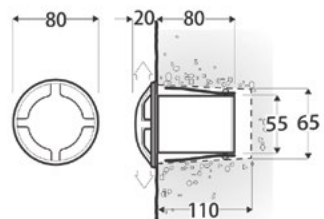

RANGE
Copper
SKL-MB-CO



Bronze finish
SKL-MB-BR



Natural Anodised
SKL-MB-SN



Black Anodised
SKL-MB-BK

SPECIFICATIONS

- Machined Bezel
- Spun raw Copper bodies
- Spun raw Aluminium bodies Marine anodised to 25 microns (um)
- IP Rating - IP65
- LAMPS**
- 12V LED MR16 3 - 10W
- OPTIONS**
- Remote transformer 12 Volt



Mini Step Light
recessed

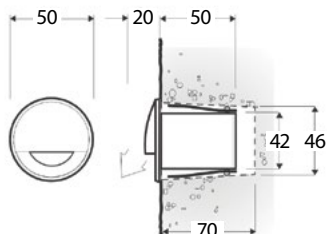

RANGE
Bronze finish
MSTL-MB-BR



Natural Anodised
MSTL-MB-SN



Black Anodised
MSTL-MB-BK

SPECIFICATIONS

- CNC machined Bezel
- Spun raw Copper bodies
- Spun raw Aluminium bodies
Marine anodised to 25 microns (um)
- IP Rating - IP65

LAMPS

- 12V LED MR11 3W

OPTIONS

- Remote transformer 12 Volt



Mini Up Light
Inground

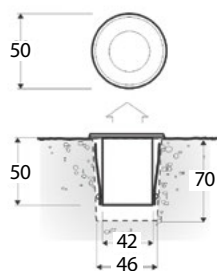

RANGE
Bronze finish
MIGUL-MB-BR



Natural Anodised
MIGUL-MB-SN



Black Anodised
MIGUL-MB-BK

SPECIFICATIONS

- CNC machined Bezel
- Spun raw Copper bodies
- Spun raw Aluminium bodies
Marine anodised to 25 microns (um)
- IP Rating - IP65

LAMPS

- 12V LED MR11 3W

OPTIONS

- Remote transformer 12 Volt

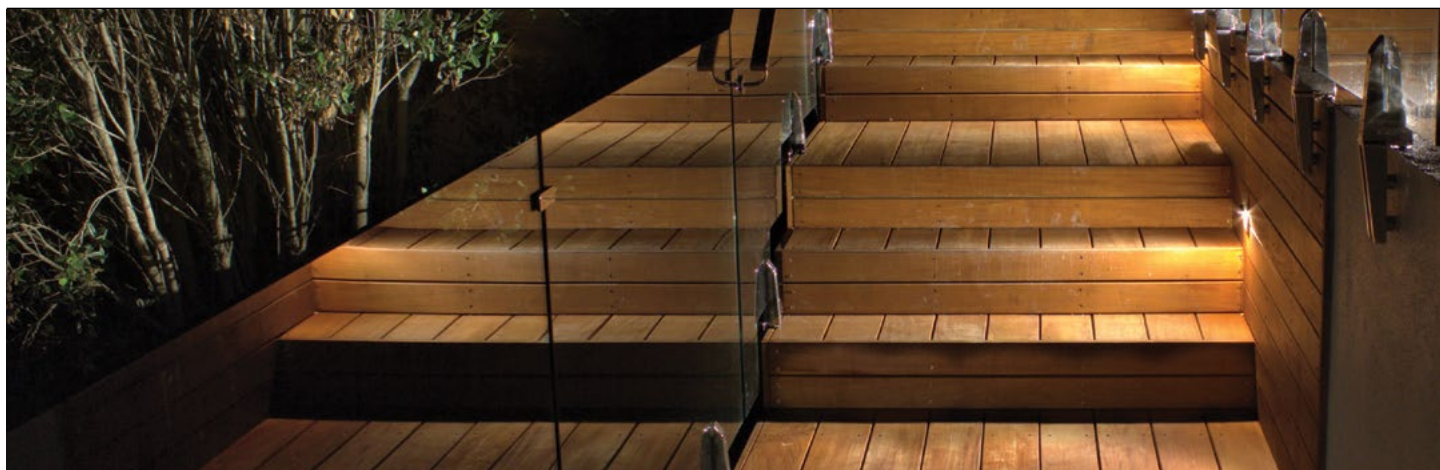

NOTE: AVAILABLE WITH OR WITHOUT LAMPS

Surface mount LED step lights 06

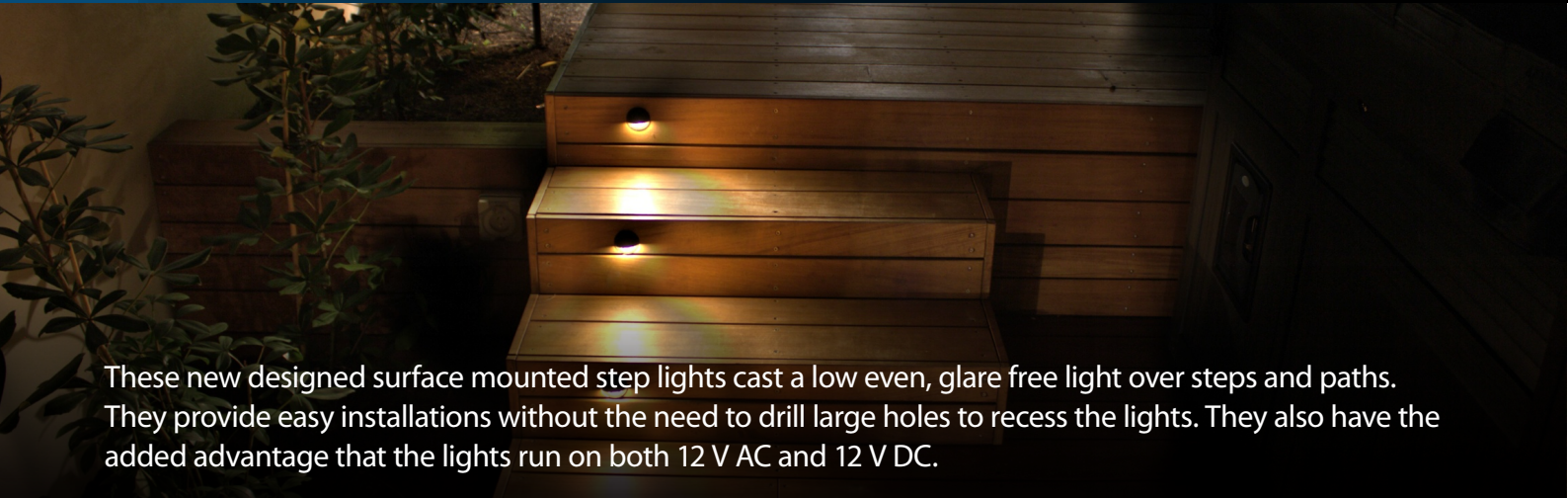

These new designed surface mounted step lights cast a low even, glare free light over steps and paths. They provide easy installations without the need to drill large holes to recess the lights. They also have the added advantage that the lights run on both 12 V AC and 12 V DC.

Step Light eyelid Surface mounted

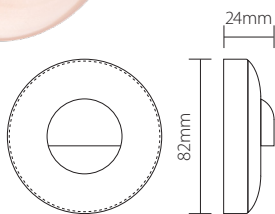

RANGE

-  Raw Copper
SMSTP-SB-CO
-  Natural Anodised
SMSTP-SB-SN
-  Black Anodised
SMSTP-SB-BK

Step Light louver Surface mounted

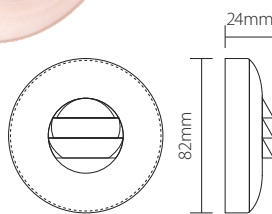

RANGE

-  Raw Copper
SMSTP-SB-LV-CO
-  Natural Anodised
SMSTP-SB-LV-SN
-  Black Anodised
SMSTP-SB-LV-BK

Step Light machined Surface mounted

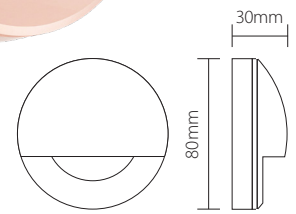

RANGE

-  Copper
SMSTP-MB-CO
-  Bronze finish
SMSTP-MB-BR
-  Natural Anodised
SMSTP-MB-SN
-  Black Anodised
SMSTP-MB-BK

SPECIFICATIONS

Watts	2.5
Lumens	180 LM
Diode	Samsung
Colour temp	Warm White 2700 K minimum 3000 K maximum
Beam Angle	90°
Lifespan	18,000 Hours

IP Rating	IP 65
CRI	80
Input	12 V AC/DC
Diameter	80 mm
Height	Spun Bezels 24 mm Machined Bezels 30 mm
Material	BODY Marine Grade Anodised Aluminium

Material	BEZELS Spun Raw Copper or Aluminium Marine Grade Anodised
Classification	IC
Warranty	5 years (excluding the lamp)

Design App NZ 424877



Up Light spun
inground

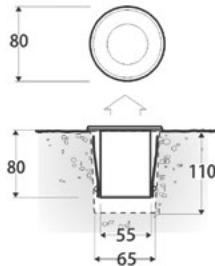

RANGE



Raw Copper
ULIG-SB-CO



Natural Anodised
ULIG-SB-SN



Black Anodised
ULIG-SB-BK

SPECIFICATIONS

- Spun raw Copper bodies
- Spun raw Aluminium bodies Marine anodised to 25 microns (um)
- IP Rating - IP65
- LAMPS**
- 12V LED MR16 3 - 10W
- OPTIONS**
- Remote transformer 12 Volt



Up Light machined
inground

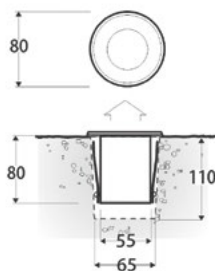

RANGE



Bronze finish
ULIG-MB-BR



Raw Copper
ULIG-MB-CO



Natural Anodised
ULIG-MB-SN



Black Anodised
ULIG-MB-BK

SPECIFICATIONS

- Machined Bezel
- Spun raw Copper bodies
- Spun raw Aluminium bodies Marine anodised to 25 microns (um)
- IP Rating - IP65
- LAMPS**
- 12V LED MR16 3 - 10W
- OPTIONS**
- Remote transformer 12 Volt



Lawn Light
inground

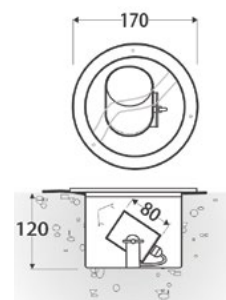

RANGE

Raw Copper
LLIG-CO

SPECIFICATIONS

- Spun raw Copper
- IP Rating - IP65
- LAMPS**
- 12V LED MR16 5 - 7W
- OPTIONS**
- Remote transformer 12 Volt



Underwater Light
surface mount

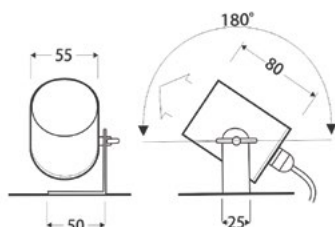

RANGE

Raw copper
UWL-SM-CO

SPECIFICATIONS

- Spun raw Copper
- IP Rating - IP67
- LAMPS**
- 12V LED MR16 5 - 7W
- OPTIONS**
- Remote transformer 12 Volt



Spot Light
surface mounted fixed

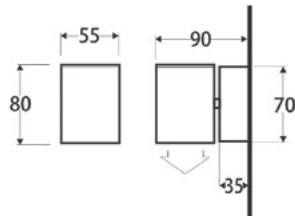

RANGE



Raw Copper
SMSL-FX-CO



Natural Anodised
SMSL-FX-SN



Black Anodised
SMSL-FX-BK

SPECIFICATIONS

- Spun raw Copper
- Spun raw Aluminium Marine anodised to 25 microns (um)
- IP Rating - IP65
- LAMPS**
- 12V LED MR16 3 - 10W
- OPTIONS**
- 230V Volt GU10
- Integral transformer 12 Volt Requires 50mm deep base
- Remote transformer 12 Volt



Spot Light
surface mounted adjustable

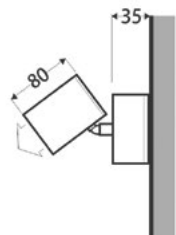

RANGE



Raw Copper
SMSL-A-CO



Natural Anodised
SMSL-A-SN



Black Anodised
SMSL-A-BK

SPECIFICATIONS

- Spun raw Copper
- Spun raw Aluminium Marine anodised to 25 microns (um)
- IP Rating - IP65
- LAMPS**
- 12V LED MR16 3 - 10W
- OPTIONS**
- 230V Volt GU10
- Integral transformer 12 Volt Requires 50mm deep base
- Remote transformer 12 Volt



Spot Light
surface endmounted adjustable

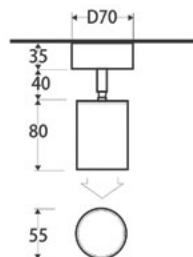

RANGE



Raw Copper
SMSL-EM-A-CO



Natural Anodised
SMSL-EM-A-SN



Black Anodised
SMSL-EM-A-BK

SPECIFICATIONS

- Spun raw Copper
- Spun raw Aluminium Marine anodised to 25 microns (um)
- IP Rating - IP65
- LAMPS**
- 12V LED MR16 3 - 10W
- OPTIONS**
- Integral transformer 12 Volt Requires 50mm deep base
- Remote transformer 12 Volt



Up/Down Light
surface mounted

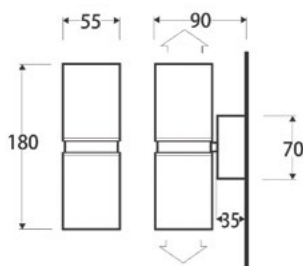

RANGE



Raw Copper
SMUD-CO



Natural Anodised
SMUD-SN



Black Anodised
SMUD-BK

SPECIFICATIONS

- Spun raw Copper
- Spun raw Aluminium Marine anodised to 25 microns (um)
- IP Rating - IP65
- LAMPS**
- 12V LED MR16 3 - 10W
- OPTIONS**
- 230V Volt GU10
- Integral transformer 12 Volt Requires 50mm deep base
- Remote transformer 12 Volt



Twin Spot Light
surface mounted

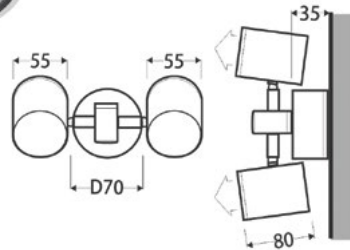

RANGE



Raw Copper
SMTSL-A-CO



Natural Anodised
SMTSL-A-SN



Black Anodised
SMTSL-A-BK

SPECIFICATIONS

- Spun raw Copper
- Spun raw Aluminium Marine anodised to 25 microns (um)
- IP Rating - IP65
- LAMPS**
- 12V LED MR16 3 - 10W
- OPTIONS**
- Integral transformer 12 Volt Requires 50mm deep base
- Remote transformer 12 Volt



Double Spot Light
surface mounted adjustable

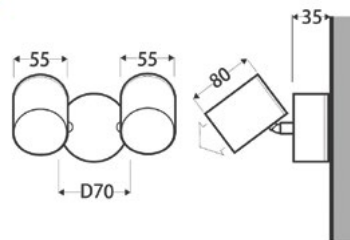

RANGE



Raw Copper
SMSL-AD-CO



Natural Anodised
SMSL-AD-SN



Black Anodised
SMSL-AD-BK

SPECIFICATIONS

- Spun raw Copper
- Spun raw Aluminium Marine anodised to 25 microns (um)
- IP Rating - IP65
- LAMPS**
- 12V LED MR16 3 - 10W
- OPTIONS**
- Integral transformer 12 Volt Requires 50mm deep base
- Remote transformer 12 Volt



Spot Light
surface endmounted fixed

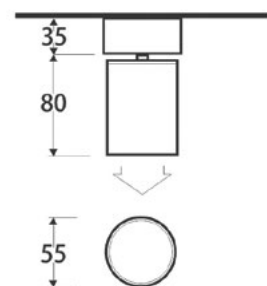

RANGE



Raw Copper
SMSL-EM-FX-CO



Natural Anodised
SMSL-EM-FX-SN



Black Anodised
SMSL-EM-FX-BK

SPECIFICATIONS

- Spun raw Copper
- Spun raw Aluminium Marine anodised to 25 microns (um)
- IP Rating - IP65
- LAMPS**
- 12V LED MR16 3 - 10W
- OPTIONS**
- Integral transformer 12 Volt Requires 50mm deep base
- Remote transformer 12 Volt



Down Light
recessed

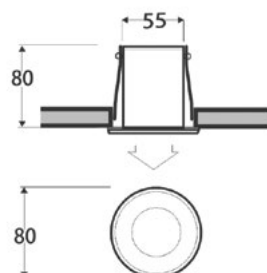

RANGE



Bronze finish
DL-RMB-BR



Natural Anodised
DL-RMB-SN



Black Anodised
DL-RMB-BK

SPECIFICATIONS

- CNC machined Bezel
- Spun raw Copper bodies
- Spun raw Aluminium bodies Marine anodised to 25 microns (um)
- IP Rating - IP65
- LAMPS**
- 12V LED MR11 3W
- OPTIONS**
- Remote transformer 12 Volt

Wall Light adjustable with ground spike to wall-mounted

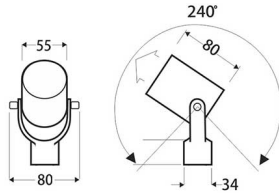

RANGE



Raw Copper
ECOWALL-CO



Natural Anodised
ECOWALL-SN



Black Anodised
ECOWALL-BK

SPECIFICATIONS

- Spun raw Copper
- Spun raw Aluminium
Marine anodised to
25 microns (um)
- IP Rating - IP65

LAMPS

- 12V LED MR16 3 - 10W

OPTIONS

- Remote transformer 12 Volt



Glare shields



Light with/without Glare shields



Louver & Honeycomb filters



Bollard groundspikes

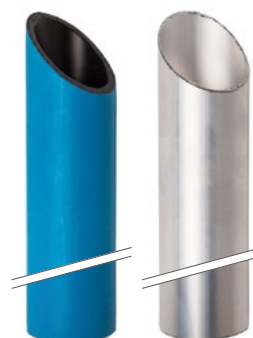

Garden light ground spike



Installation cans



Bollard surface mount bezel



MR16 LED Lamps



GU10 LED Lamps



12V G4 LED capsules





Why Moonscape™ lighting?

Like painting on a black canvas, lighting a landscape is an art. Each beam of light can bring life and magic to your garden at night. Exterior lighting can enhance your landscape with a subtle beauty, illuminate focal points, add drama and extend your living space. As well as providing pleasure, creative lighting increases the value of your property.

Developing an exterior lighting scheme is a careful balancing act between creating the right atmosphere, managing safety issues and selecting cost effective fittings. That's why you need the experts. It is important to consult with a lighting designer or landscape architect when planning your outdoor lighting project.

For professional advice on any lighting project or assistance with the MOONSCAPE[®] range, contact us at info@moonscape.nz

They will help you with the complex aspects of exterior lighting including:

- Creating the atmosphere you want
- Best use and definition of space
- The safety of people and security of your home
- Spill light and minimise glare
- Placement of control equipment and switching
- Installation, operation and maintenance costs
- Installation, operation and maintenance costs
- Energy efficiency

10 YEARS
WARRANTY
*on all 12V lights

Moonscape is manufactured in New Zealand producing high quality lights made to the highest quality and standard. We also manufacture our products using the latest technology - CNC Machining, Injection Moulding, Hand Spinning & Hand Assembly.

